

GLASS ARCHITECTURAL HARDWARE SOLUTION

Define[®]
Innovative Insight-Inspire

DEFINE OVERSEAS PVT. LTD.

Rajkot. 360 004 Gujarat, INDIA

Tele: +91 97277 61148
E-Mail: info@definehardware.in

www.definehardware.in

  / definehardware



Define[®]
Innovative Insight-Inspire

Define[®]
Innovative Insight-Inspire



OUR MISSION:

Our mission is to provide quality product along with the best customer service with product guarantee. We are committed to provide satisfaction to each and every customer we serve.

OUR WAY OF WORK

Imagination paves way to innovation - followed with wisdom, we focus on thorough research and development on products. While designing the products, we value the opinion of reputed architects and interior designers, to ensure better quality, convenience with comfort and grace.

SUPERIOR QUALITY, WITH GREATER CONSISTENCY:

Surpassing expectation has its own pleasure and rewards. We, at Define always believed in the virtues of this simple dictum. Whether it is about designing our products or to create bonding with customers, we believe in surpassing expectations. Established in 2009, Based in Rajkot and one of the most rapidly growing industrial areas of Western India. Within a short span of time, with our dedicated efforts and streamlined expertise, we have earned a name as the leading manufacturer of glass hardware architectural products. We supply domestic as well as international products. Consistency and superior quality is what defines us in the market.

METHODOLOGY:

We are fully aware that the hardware architectural product market is full of competition and only way to stand exceptional is to ensure super quality at the most competitive prices. We give immense importance to the selection of raw material and ensure highest level of quality control. With skillful workforce on our side, we have setup a state-of-the-art manufacturing facility, to augment the expertise and convert the designs into excellent product. A go-getter sales force with sound technical expertise helps us to create strong bond with the customers, giving an edge to the brand and company.

Statement to build long term relationships with our customers and Clients and provide exceptional customer services by pursuing business through innovation and advanced technology.

To Provide quality services that exceeds the expectations of our esteemed customers and also to build long term relationships with our customers and clients and provide exceptional customer services by pursuing business through innovation and advanced technology. To be leader in the bathroom fitting industry by providing enhanced services, relationship and profitability.

INDIA **1ST**
MANUFACTURER
GLASS ARCHITECTURAL HARDWARE SOLUTION

● Test Report & Certificate

Exova Unifred (Abu Dhabi) T: +971 (0)2 558 2345
P.O. Box 9199 E: abu@exova.com
Abu Dhabi W: www.exova.com
United Arab Emirates

TEST CERTIFICATE

Client: Define Middle East DWC LLC
P.O. Box: 390867, Dubai
United Arab Emirates

Exova Ref: A 708483; Issue 1
Order No.: Define
Date Tested: 16/11/17
Date Reported: 18/11/17

Contact: Ms. Neharika

Specification: ASTM B117-16

Description: Stainless Steel Shower Hinge for salt spray test
Origin: Define India, Material Grade: SS316
Test Duration: 72 hours

Exova Dubai job reference#: D704680

TEST DETAILS

Test Solution	Test Temperature (°C)	pH	Collected Solution Fall Out Rate (ml/hour)	Specific Gravity (g/ml)
5% NaCl	35±1.2	6.6-6.8	1-2	1.028-1.031

Certificate Comments:

- Test specimen provided by client.
- Evaluation was carried out by visual examination only. (See attached detailed salt spray report).
- Test specimen was cleaned by using running water after finish the test before examination.

Tested by: Umm Al Naar, Abu Dhabi

Pratap Reddy
Lab Manager
Metallurgy

For and on authority of
Exova Limited (Abu Dhabi)

A78483; Issue 1

● Test Report & Certificate

TEST REPORT

Job No: 152/007/0424

Client: DEFINE OVERSEAS PVT. LTD.

Material: Stainless Steel Shower Hinge

ELEMENTS	OPERATION	REQUIRED VALUE
% CARBON	0.022	0.03 max
% SILICON	0.220	1.00 max
% MANGANESE	0.480	2.00 max
% PHOSPHORUS	0.032	0.035 max
% SULPHUR	0.005	0.030 max
% CHROMIUM	18.330	18.00-21.00
% NICKEL	8.470	8.00-12.00

South Asia

CERTIFICATE

The Certification Body
of TÜV SÜD South Asia Private Limited
certifies that

DEFINE OVERSEAS PVT LTD
AVREST IND. AREA, PLOT 24, OPP. POONAM DUMPER,
GONDAL ROAD, RAJKOT - 360 004, India

has implemented Quality Management System
in accordance with **ISO 9001:2015**
for the scope of

Manufacturer of architectural hardware products like spider fittings & routel fittings, glass sliding folding system, patch fittings and Glass door handle and mortise handle, railing, glass shower cubical and automatic sensor door.

The certificate is valid from **2022-12-06** until **2025-12-05**
Subject to successful completion of annual periodic audits
The present status of this certificate can be obtained through TUV SUD website by scanning below QR code and by entering the certificate number (without spaces) on web page. Further clarifications regarding the status & scope of this certificate may be obtained by consulting the certification body at info.in@tuvsud.com

Certificate Registration No. **99 100 22837**
Date of Initial certification: **2022-12-06**
Issue Date: **2022-12-06 Rev. 00**

Rahul Kale
Head of Certification Body
of TÜV SÜD South Asia Private Limited,
Mumbai
Member of TÜV SÜD Group

TÜV SÜD South Asia Pvt. Ltd. ● TÜV SÜD House ● Saki Naka ● Andheri (East) ● Mumbai – 400072 ● Maharashtra ● India

ZERTIFIKAT ♦ CERTIFICATE ♦ 證書 ♦ CERTIFICADO ♦ CERTIFICAT ♦ CERTIFICATE ♦

Certificate of Compliance

This is to certify that the technical documentation for the product:

ARCHITECTURAL HARDWARE PRODUCTS LIKE SPIDER FITTINGS & ROUTEL FITTINGS, GLASS SLIDING, FOLDING SYSTEM, PATCH FITTINGS AND DOOR PULL HANDLES AND MORTISE HANDLES, RAILING, GLASS SHOWER CUBICAL AND AUTOMATIC SENSOR DOOR, WOODEN DOOR AND WINDOW FITTING.

Manufactured by:

DEFINE OVERSEAS PVT. LTD.

EVEREST INDUSTRIAL AREA, PLOT 24, OPP. POONAM DUMPER, GONDAL ROAD, RAJKOT-360004, GUJARAT, INDIA.

Complies with the requirements (technical documentation including inspection & test results) of General Product Safety Directive 2001/95/EC. Hence manufacturer's declaration of conformity according to above regulation is accepted. DEFINE OVERSEAS PVT. LTD. Can place the CE marking as per laid down regulations on the products mentioned above.

Certificate Number / Certificate No.: RSBV-2405-7489

Datum Van Publicatie / Date of Issue: 22/05/2024

1st Annual surveillance audit due on: 21/05/2025

2nd Annual surveillance audit due on: 21/05/2026

Vervaldatum / Date of Expiry: 21/05/2027

Royal Stancert B.V.
Rust Office - Jan Eindhoven 701, 1114 AB Amsterdam, The Netherlands
Rijksoverheid 712161 / RIN 53171217 - Rijksoverheid - Besluit Besluit
This certificate remains the property of Royal Stancert B.V. and must be returned whenever demanded. The validity of this certificate can be verified at www.stancert.com. Royal Stancert B.V. is an independent control and personal assessment body accredited by United Kingdom Accreditation Service (UKAS) 6536 (United Kingdom).

ISO 9001:2015
CERTIFIED

NSIC
CERTIFIED CO.

TEST REPORT

Job No: 152/007/0424

Client: DEFINE OVERSEAS PVT. LTD.

Material: Stainless Steel Shower Hinge

ELEMENTS	OPERATION	REQUIRED VALUE
% CARBON	0.022	0.03 max
% SILICON	0.443	1.00 max
% MANGANESE	0.842	2.00 max
% PHOSPHORUS	0.040	0.035 max
% SULPHUR	0.004	0.030 max
% CHROMIUM	17.270	18.00-21.00
% NICKEL	8.670	8.00-12.00

DEFINE MANUFACTURING UNIT



WE FOCUS ON YOUR NEEDS

Your requirements are our top priority. We do everything to understand what motivates you as our customers, partners and users. To develop solutions that do everything they promise to do. And that do not just meet your expectations, but exceed them.



FACING CHALLENGES WITH DETERMINATION

We are constantly seeking new ways to develop our access solutions. To do this we face up to new challenges and seek solutions that deliver genuine added value for our customers and users.



SHAPING THE FUTURE THROUGH CURIOSITY

Progress is driven by curiosity. That is why we ask questions, research and recognize trends, always looking ahead. This translates into products, solutions and services that help our customers on their path to the future and help make access smarter and more secure.



OUR PERFORMANCE FOR YOUR GOALS

We have a clear goal: your satisfaction. We maintain high standards when it comes to security, quality and reliability, so with our products, solutions and services, you will know you are in good hands.



EARNING YOUR TRUST

We stand for reliability. We strive to help our customers feel good about having a trusted partner on their side at all times. This is reflected in our products, solutions and services.



FRAMELESS SHOWER FITTINGS



GLASS DOOR FITTINGS



GLASS FACADISM



GLASS SLIDING FOLDING SYSTEM



GLASS DOOR LOCK FITTINGS

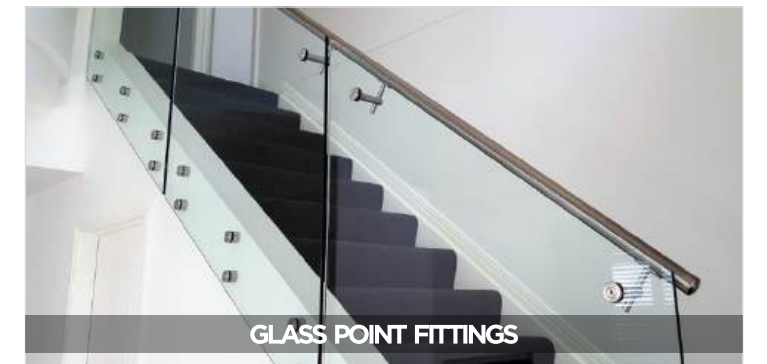

GLASS POINT FITTINGS



WOODEN DOOR FITTINGS



RAILING FITTINGS



GLASS GLAZING PROFILE

● Frameless Shower Fittings



DF-SH-11
(SSS/PSS)

DF-SH-12
(SSS/PSS)

DF-SH-13
(SSS/PSS)

DF-SH-14
(SSS/PSS)

● Shower Hinges
S.S.304/316

● ● ● ● - Available Finish



DF-SH-15
(SSS/PSS)

DF-SH-16
(SSS/PSS)

DF-SH-17
(SSS/PSS)

● Frameless Shower Fittings



● Bevel Shower Hinges
S.S. 304/316

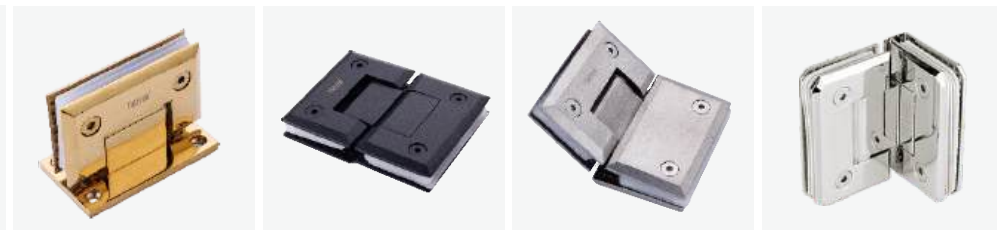

DF-SHB-18
(PSS/SSS)

DF-SHB-19
(PSS/SSS)

DF-SHB-20
(PSS/SSS)

DF-SHB-21
(PSS/SSS)



DF-SHB-22
(PSS/SSS)

DF-SHB-23
(PSS/SSS)

● Frameless Shower Fittings

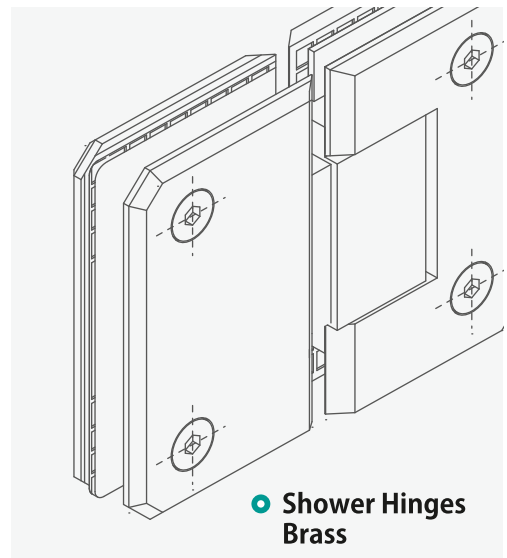

● Shower Hinges
Brass



DF-BSH-11
(SSS/PSS)

DF-BSH-12
(SSS/PSS)

DF-BSH-13
(SSS/PSS)

DF-BSH-14
(SSS/PSS)



DF-BSH-15
(SSS/PSS)

DF-BSH-16
(SSS/PSS)

● SSS / PSS ● Black Matt ● Gold PVD ● Rose Gold PVD

— Order Subject To Availability

● Frameless Shower Fittings

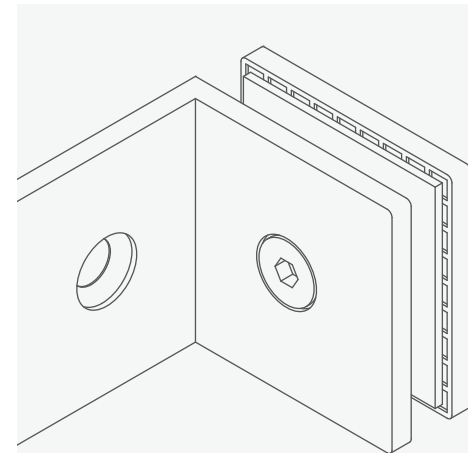

● Glass Connector
S.S.304/316



DF-GC-01
(SSS/PSS)

DF-GC-02
(SSS/PSS)

DF-GC-03
(SSS/PSS)

DF-GC-04
(SSS/PSS)



DF-GC-05
(SSS/PSS)

DF-GC-06
(SSS/PSS)

DF-GC-07
(SSS/PSS)

DF-GC-08
(SSS/PSS)



DF-GC-09
(SSS/PSS)

DF-GC-11
(SSS/PSS)

DF-GC-12
(SSS/PSS)

● Frameless Shower Fittings



● Sheet Metal
Glass Connector 304/316



DF-SMGC-111
(SSS/PSS)

DF-SMGC-112
(SSS/PSS)

DF-SMGC-113
(SSS/PSS)

DF-SMGC-114
(SSS/PSS)



DF-SMGC-115
(SSS/PSS)

DF-SMGC-116
(SSS/PSS)

DF-SMGC-117
(SSS/PSS)

● SSS / PSS ● Black Matt ● Gold PVD ● Rose Gold PVD

— Order Subject To Availability

● Frameless Shower Fittings



● Glass Connector Brass



DF-BGC-01
(BN/CP)



DF-BGC-02
(BN/CP)



DF-BGC-04
(BN/CP)



DF-BGC-05
(BN/CP)

● Frameless Shower Fittings

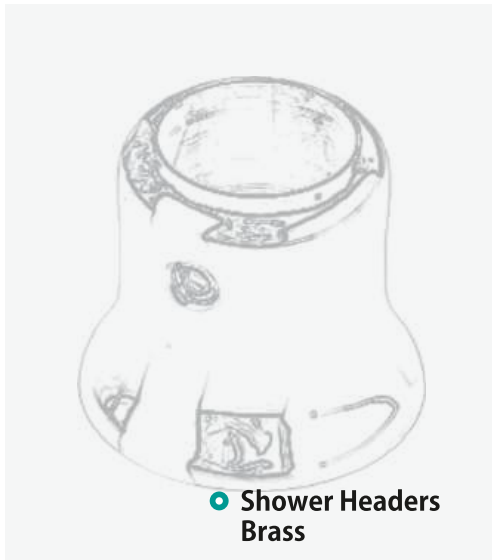

● Shower Headers Brass



DF-SB-01
(BN/CP)



DF-SB-02
(BN/CP)



DF-SB-03
(BN/CP)



DF-SB-04
(BN/CP)



DF-SB-05
(BN/CP)



DF-SB-06
Ø19 (SSS/PSS)

● Frameless Shower Fittings

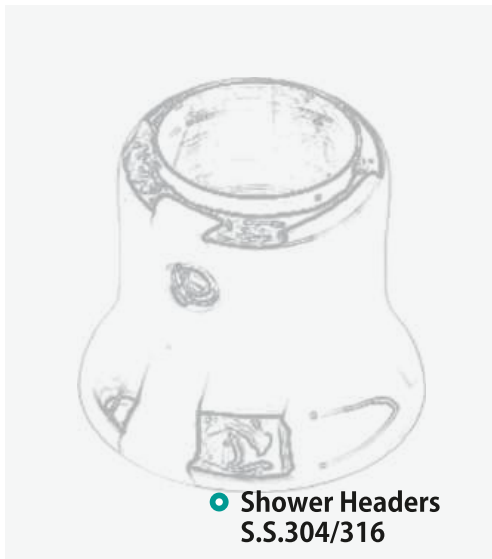

● Shower Headers S.S.304/316



DF-SSB-01
Ø19 / 25 mm Pipe
(SSS/PSS)



DF-SSB-02
Ø19 / 25 mm Pipe
(SSS/PSS)



DF-SSB-03
Ø19 / 25 mm Pipe
(SSS/PSS)



DF-SSB-04
Ø19 / 25 mm Pipe
(SSS/PSS)



DF-SSB-05
Ø19 / 25 mm Pipe
(SSS/PSS)



DF-SSB-09
(SSS/PSS)



DF-SSB-10
(SSS/PSS)



DF-SSB-11
(SSS/PSS)

● Frameless Shower Fittings



● Shower Cubicle Glass Handle S.S.304/316



DF-SCH-06
Ø19 / 22 / 25 mm Pipe
(SSS/PSS)



DF-SCH-07
Ø 20X20 / 25X25 mm Pipe
(SSS/PSS)

● Frameless Shower Fittings



● Shower Glass Knob S.S.304/316

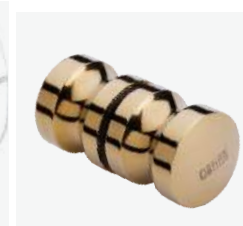

DF-SKB-07
(SSS/PSS)



DF-SKB-08
(SSS/PSS)



DF-SKB-09
(SSS/PSS)

● Frameless Shower Fittings

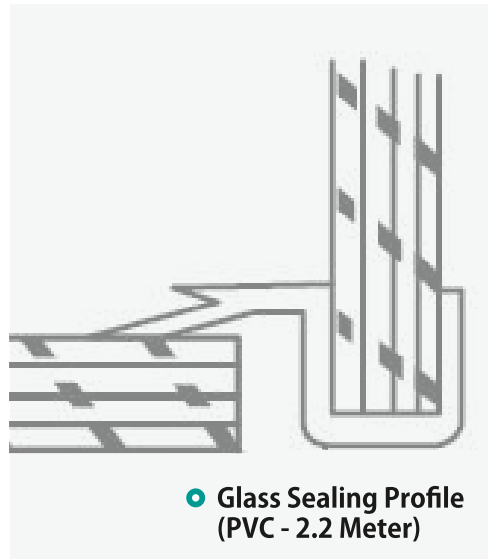

● Glass Sealing Profile (PVC - 2.2 Meter)

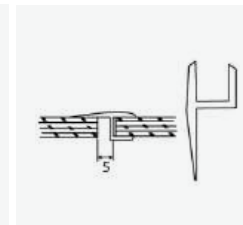

DF-GP-01
(Transparent)

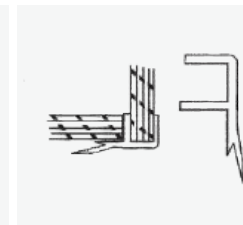

DF-GP-02
(Transparent)

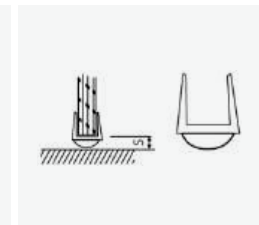

DF-GP-03
(Transparent)

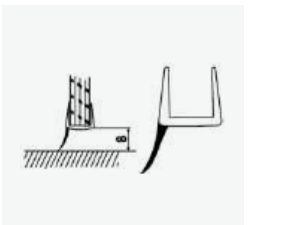

DF-GP-04
(Transparent)

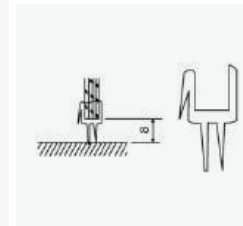

DF-GP-05
(Transparent)

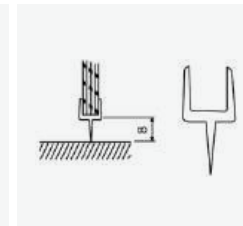

DF-GP-06
(Transparent)

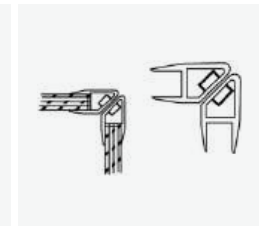

DF-GP-07
(Transparent)

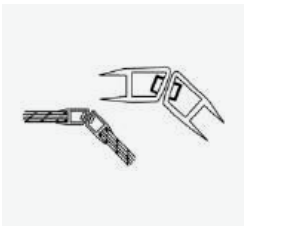

DF-GP-08
(Transparent)

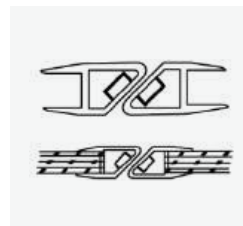

DF-GP-09
(Transparent)

● Glass Door Fittings

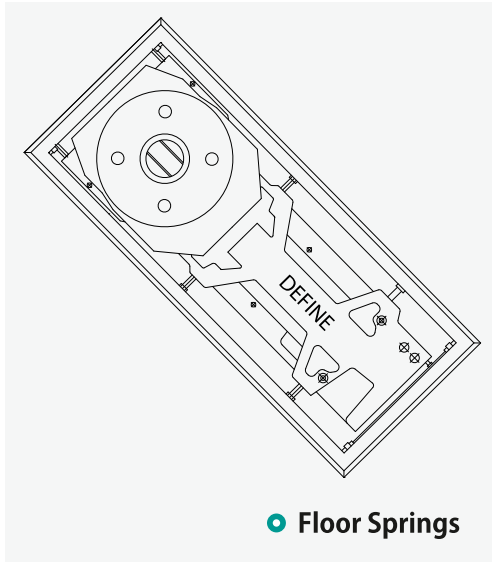

DF-FS-604
Weight Capacity : 90 Kg
(SSS)



DF-FS-904
Weight Capacity : 90 to 120 Kg
(SSS)



DF-FS-1040
Weight Capacity : 120 to 150 Kg
(SSS)



DF-FS-1041-TOP PIVOT



DF-FS-1041-BOTTOM ARM

● Glass Door Fittings



DF-HPF-90
(SSS/PSS)



DF-HPF-90 C
(SSS/PSS)



DF-HPF-91

● Glass Door Fittings

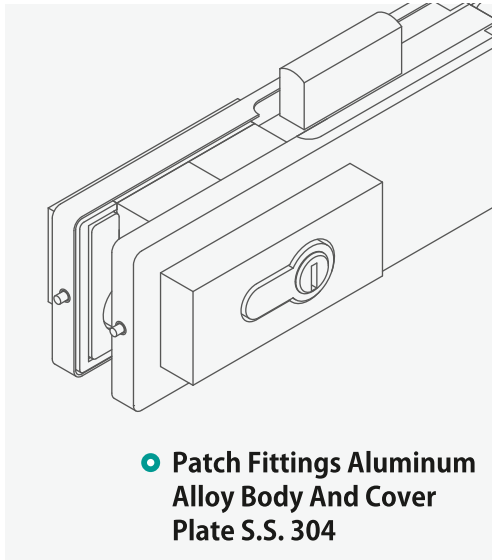

DF-PF-101
(SSS/PSS)



DF-PF-202
(SSS/PSS)



DF-PF-303
(SSS/PSS)



DF-PF-303S
(SSS/PSS)



DF-PF-404
(SSS/PSS)



DF-PF-505
(SSS/PSS)



DF-PF-606
(SSS/PSS)



DF-PF-707R
(SSS/PSS)



DF-PF-707L
(SSS/PSS)



DF-PF-808
(SSS/PSS)



DF-PF-909
(SSS/PSS)



DF-PF-1010
(SSS/PSS)

● SSS / PSS ● Black Matt ● Gold PVD ● Rose Gold PVD

— Order Subject To Availability

● Glass Door Fittings



DF-PF-64
(SSS/PSS)



DF-PF-64 ES
(SSS/PSS)



DF-PF-65
(SSS/PSS)



DF-PF-66
(SSS/PSS)



DF-PF-68
(SSS/PSS)

● Glass Door Fittings

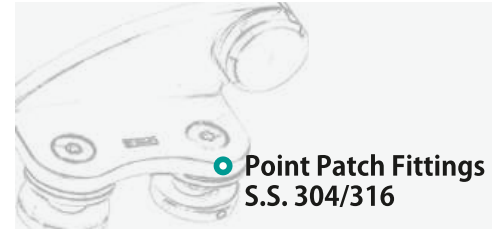

DF-PPF-222
(SSS/PSS)



DF-PPF-223
(SSS/PSS)



DF-PPF-224
(SSS/PSS)

● Glass Door Handle

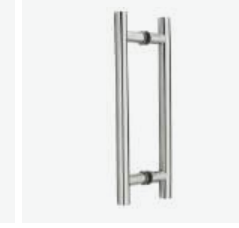
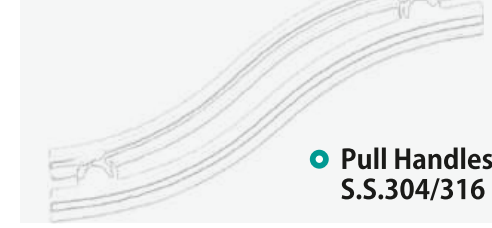

DF-PH-01
(SSS/PSS)

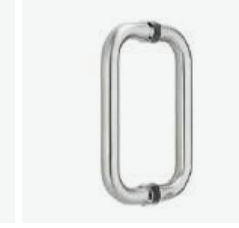

DF-PH-02
(SSS/PSS)



DF-PH-03
(SSS/PSS)



DF-PH-04
(SSS/PSS)



DF-PH-05
(SSS/PSS)

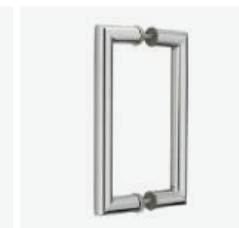

DF-PH-06
(SSS/PSS)

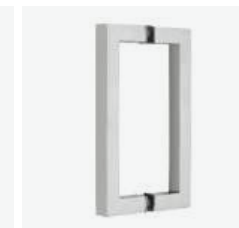

DF-PH-07
(SSS/PSS)



DF-PH-09
(SSS/PSS)



DF-PH-10
(SSS/PSS)



DF-PH-11
(SSS/PSS)

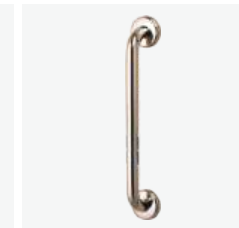

DF-GBR-01
(SSS/PSS)



DF-PH-08
(SSS/PSS)



DF-PH-08 S
(SSS/PSS)

● SSS / PSS ● Black Matt ● Gold PVD ● Rose Gold PVD

— Order Subject To Availability

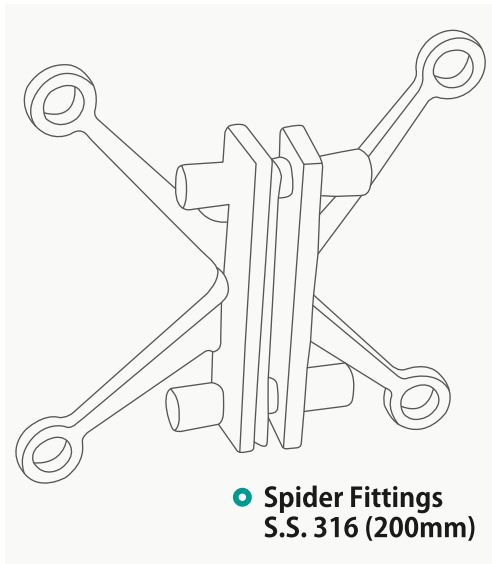

DF-01
(SSS/PSS)

DF-02
(SSS/PSS)

DF-03
(SSS/PSS)

DF-04
(SSS/PSS)



DF-05
(SSS/PSS)

DF-06
(SSS/PSS)

DF-07
(SSS/PSS)

DF-08
(SSS/PSS)



DF-09
(SSS/PSS)

DF-10
(SSS/PSS)

DF-11
(SSS/PSS)

DF-12
(SSS/PSS)

DF-13
(SSS/PSS)

Glass Facadism Fittings S.S.316 (220mm)

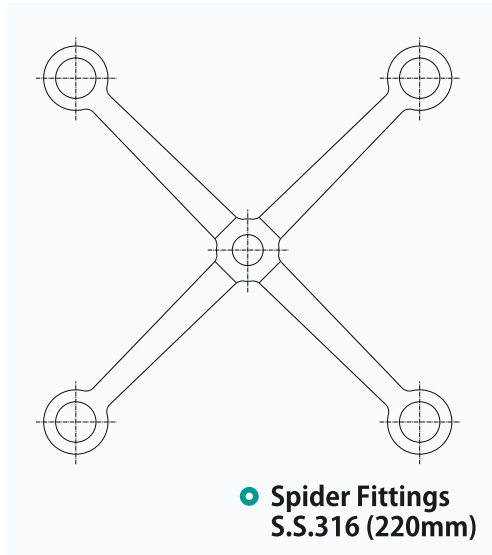

DF-SF-220
(SSS/PSS)

DF-SF-221
(SSS/PSS)

DF-SF-222
(SSS/PSS)

DF-SF-223
(SSS/PSS)



DF-SF-224
(SSS/PSS)

DF-SF-225
(SSS/PSS)

DF-SF-226
(SSS/PSS)

DF-SFP
(SSS/PSS)

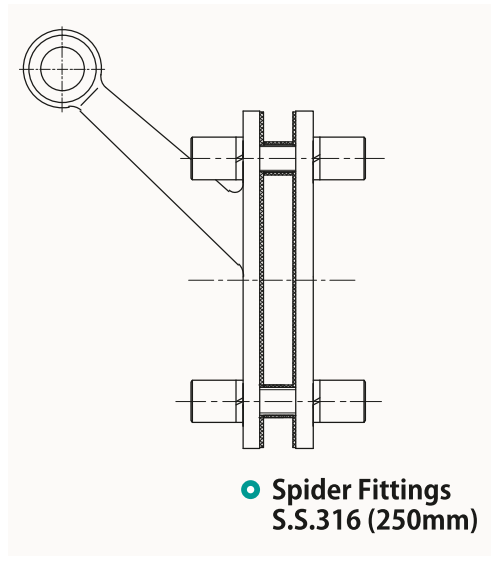

DF-PS-250 A
(SSS/PSS)

DF-PS-250 B
(SSS/PSS)

DF-PS-250 C
(SSS/PSS)

DF-PS-250 D
(SSS/PSS)



DF-FS-250 A
(SSS/PSS)

DF-FS-250 B
(SSS/PSS)

DF-FS-250 C
(SSS/PSS)

DF-FS-250 D
(SSS/PSS)



DF-FS-250 E
(SSS/PSS)

Glass Facadism Fittings S.S.316 (300mm)

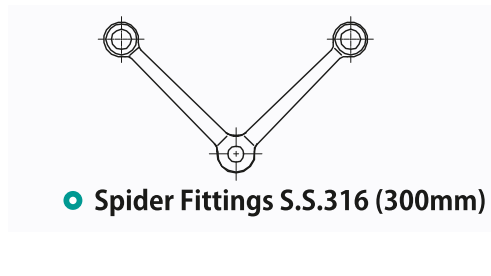

DF-PS-300 A
(SSS/PSS)

DF-PS-300 B
(SSS/PSS)

DF-PS-300 C
(SSS/PSS)

DF-PS-300 D
(SSS/PSS)



DF-FS-300 A
(SSS/PSS)

DF-FS-300 B
(SSS/PSS)

DF-FS-300 C
(SSS/PSS)

DF-FS-300 D
(SSS/PSS)

DF-FS-300 E
(SSS/PSS)

● Glass Facadism Fittings



● Routers
S.S.304 & S.S.316



DF-AR-01
(SSS/PSS)



DF-CR-02
(SSS/PSS)



DF-DR-03
(SSS/PSS)



DF-FR-04
(SSS/PSS)



DF-RS-05
(SSS/PSS)
Stud With M.S. Base



DF-RS-06 S
(SSS/PSS)
Stud With S.S. 304 Base



DF-FB-06
(SSS/PSS)



DF-FBR-07
(SSS/PSS)



DF-FC-02
(SSS/PSS)



DF-FC-07
(SSS/PSS)



DF-FC-10
(SSS/PSS)



DF-CR-24
(SSS/PSS)

● Glass Facadism Fittings

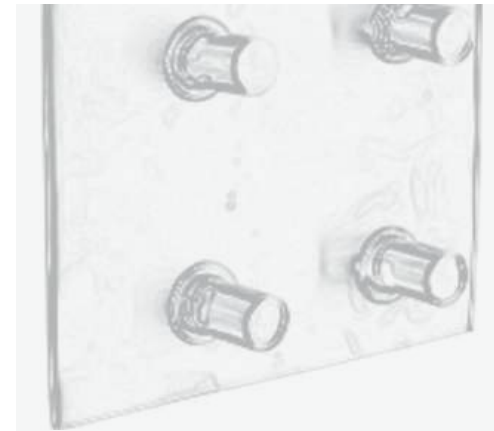

● Splice Plate
S.S.304/316



DF-SP-200
(SSS/PSS)



DF-SP-250
(SSS/PSS)



DF-SP-300
(SSS/PSS)



DF-SP-350
(SSS/PSS)

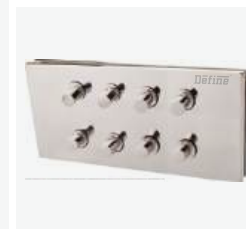

DF-SP-400
(SSS/PSS)

● Glass Facadism Fittings

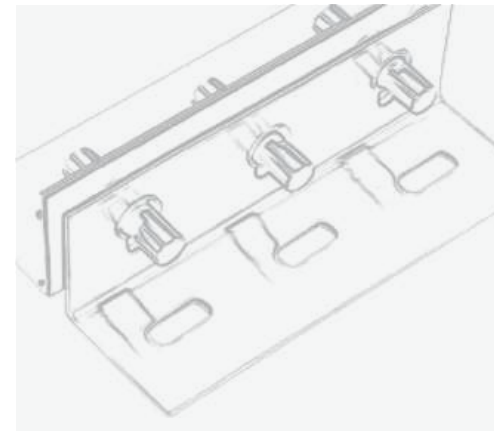

● Fin Plate
S.S.304/316



DF-FP-200
(SSS/PSS)



DF-FP-250
(SSS/PSS)



DF-FP-300
(SSS/PSS)



DF-FP-350
(SSS/PSS)



DF-FP-400
(SSS/PSS)

● Glass Facadism Fittings



● Canopy Fittings
S.S.304/316



DF-CF-031
(SSS/PSS)



DF-CF-032
(SSS/PSS)



DF-CF-033
(SSS/PSS)



DF-CF-034
(SSS/PSS)

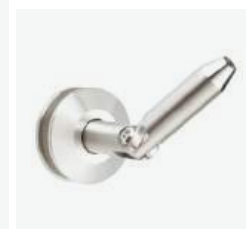

DF-CF-035
(SSS/PSS)



DF-CF-036
(SSS/PSS)



DF-CF-037
(SSS/PSS) Rod 10mm



DF-CF-038
(SSS/PSS) Rod 16mm

● Glass Sliding & Folding System - 501 P / S.S. 304

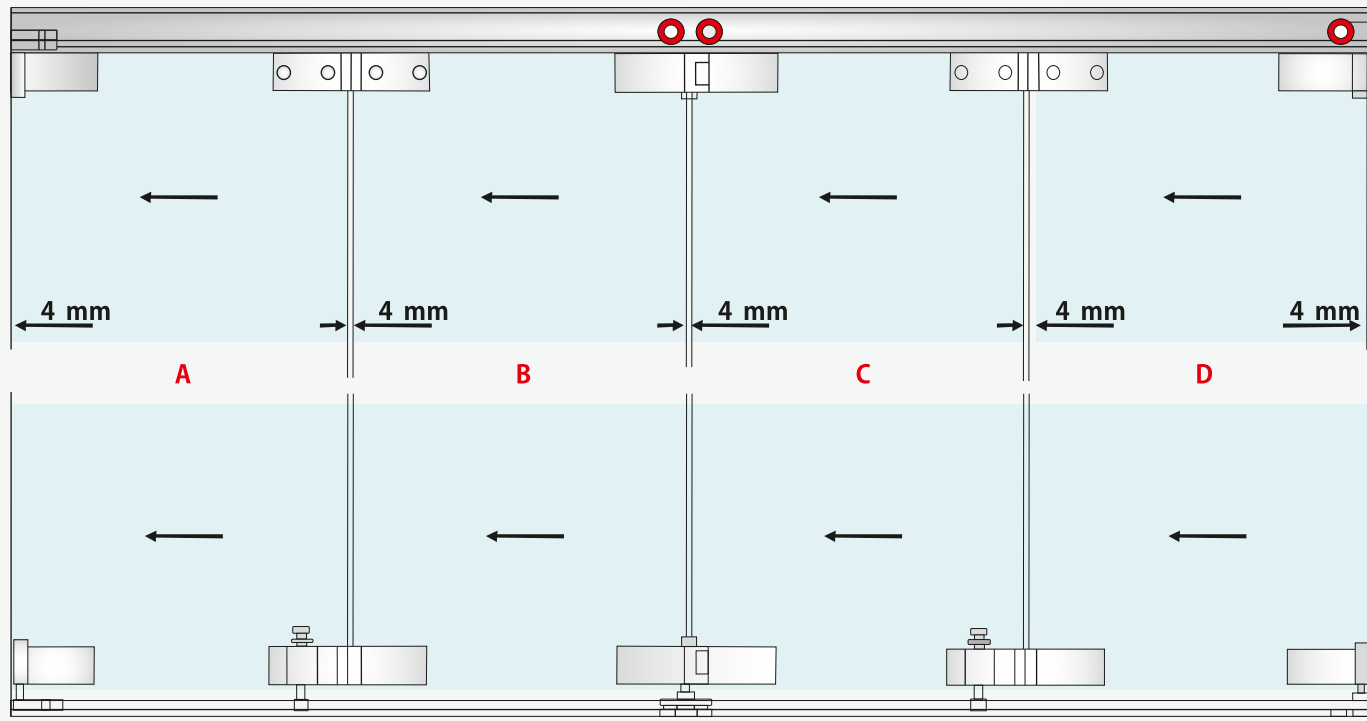

DFGSLDF - 501 - P DFGSLDF - 501 - B DFGSLDF - 501 - C DFGSLDF - 501 - B DFGSLDF - 501 - D

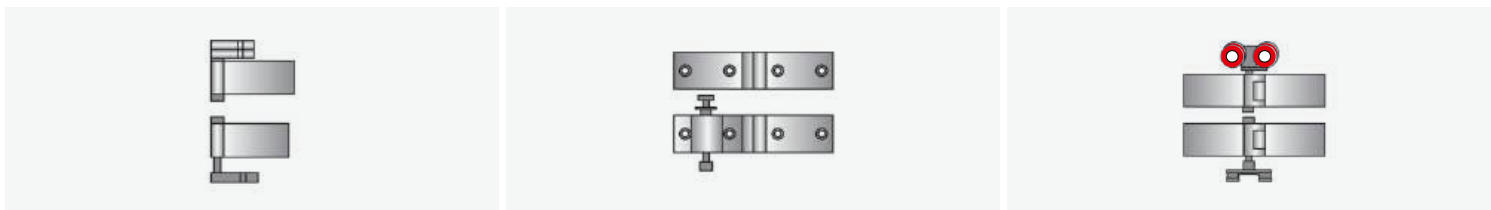

DFGSLDF-501-P
(SSS/PSS)

DFGSLDF-501-B
(SSS/PSS)

DFGSLDF-501-C
(SSS/PSS)

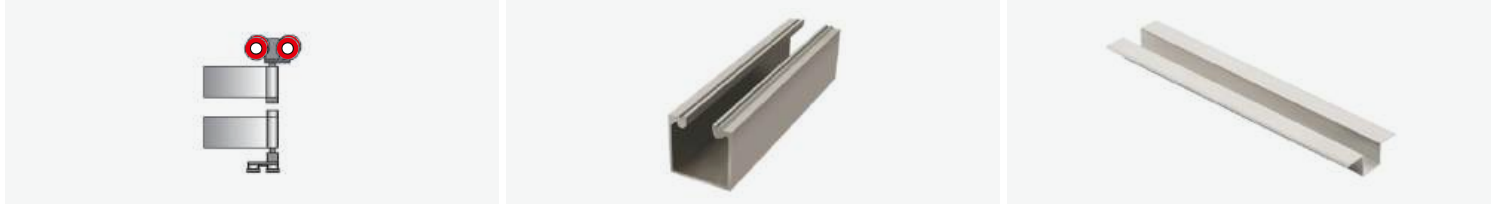

DFGSLDF-501-D
(SSS/PSS)

DF-WSGF-011
(Alu.)

DF-SC-043
(Alu.)

PRODUCT					
CODE	DFGSLDF-501-P	DFGSLDF-501-B	DFGSLDF-501-C	DFGSLDF-501-D	DFGSLDF-501-S
For 2 Glass Panel	01 Set.	01 Set.	--	01 Set.	As Per Optional
For 3 Glass Panel	01 Set.	01 Set.	01 Set.	--	As Per Optional
For 4 Glass Panel	01 Set.	02 Set.	01 Set.	01 Set.	As Per Optional
For 5 Glass Panel	01 Set.	02 Set.	02 Set.	--	As Per Optional
For 6 Glass Panel	01 Set.	03 Set.	02 Set.	01 Set.	As Per Optional

● Glass Sliding & Folding System - 511 P / S.S. 304

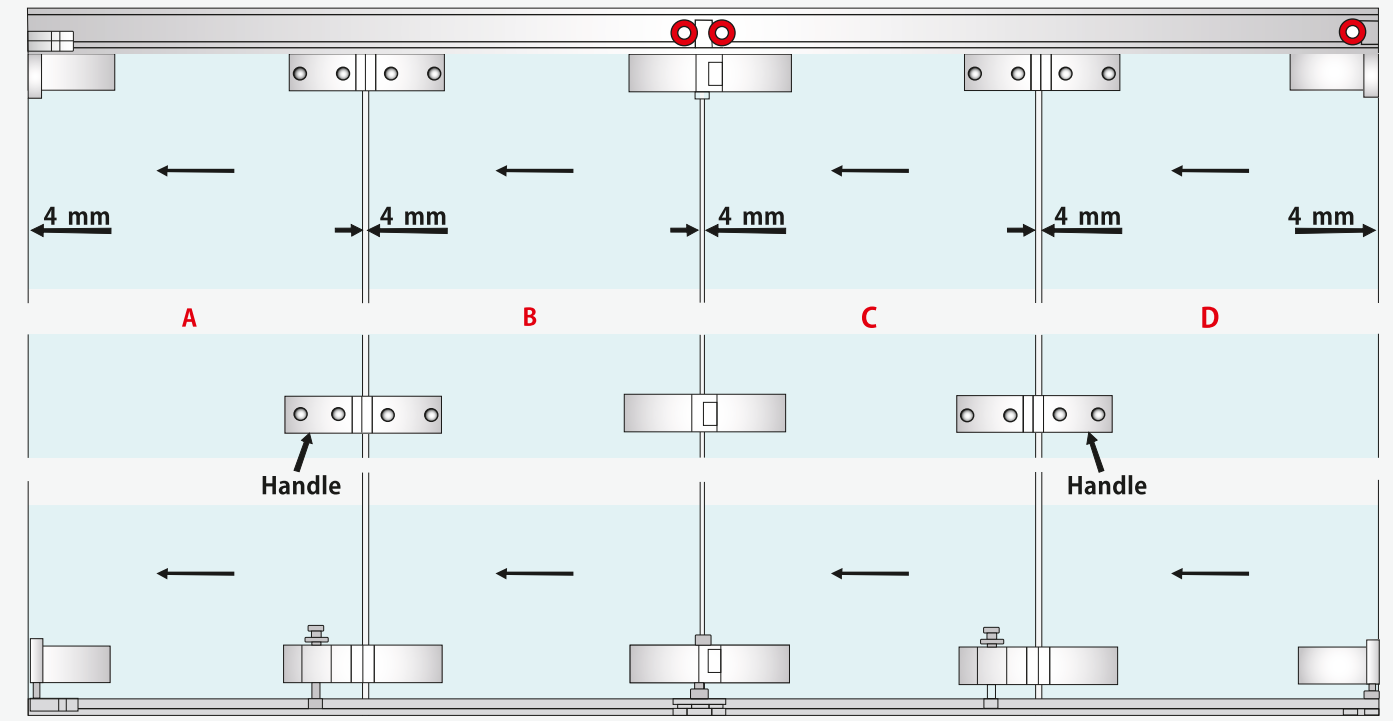

DFGSLDF - 511 - P DFGSLDF - 511 - B DFGSLDF - 511 - C DFGSLDF - 511 - B DFGSLDF - 501 - D

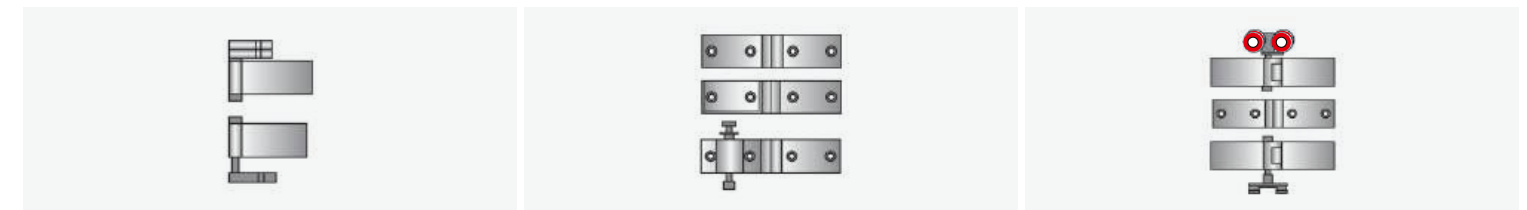

DFGSLDF-511-P
(SSS/PSS)

DFGSLDF-511-B
(SSS/PSS)

DFGSLDF-511-C
(SSS/PSS)

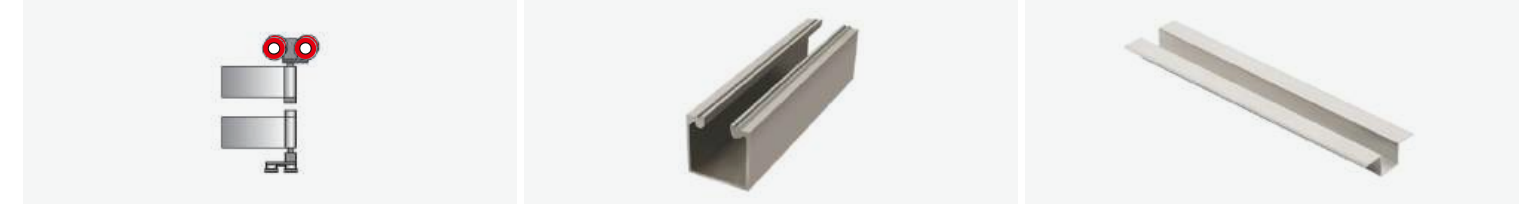

DFGSLDF-501-D
(SSS/PSS)

DF-WSGF-011
(Alu.)

DF-SC-043
(Alu.)

PRODUCT					
CODE	DFGSLDF-511-P	DFGSLDF-511-B	DFGSLDF-511-C	DFGSLDF-501-D	DFGSLDF-501-S
For 2 Glass Panel	01 Set.	01 Set.	--	01 Set.	As Per Optional
For 3 Glass Panel	01 Set.	01 Set.	01 Set.	--	As Per Optional
For 4 Glass Panel	01 Set.	02 Set.	01 Set.	01 Set.	As Per Optional
For 5 Glass Panel	01 Set.	02 Set.	02 Set.	--	As Per Optional
For 6 Glass Panel	01 Set.	03 Set.	02 Set.	01 Set.	As Per Optional

● Glass Sliding & Folding System - 501 H / S.S. 304

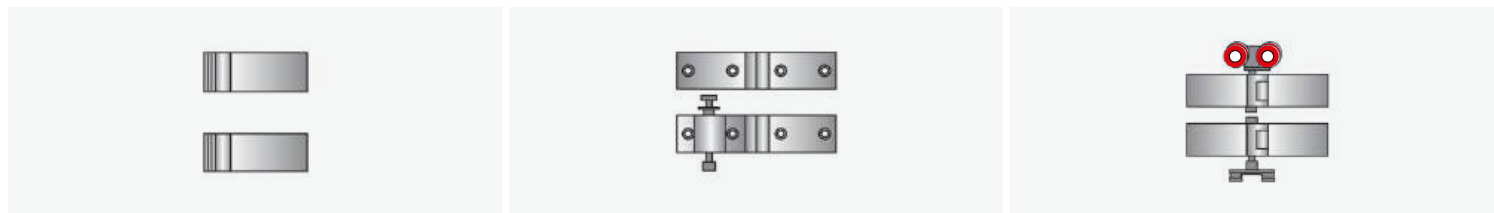
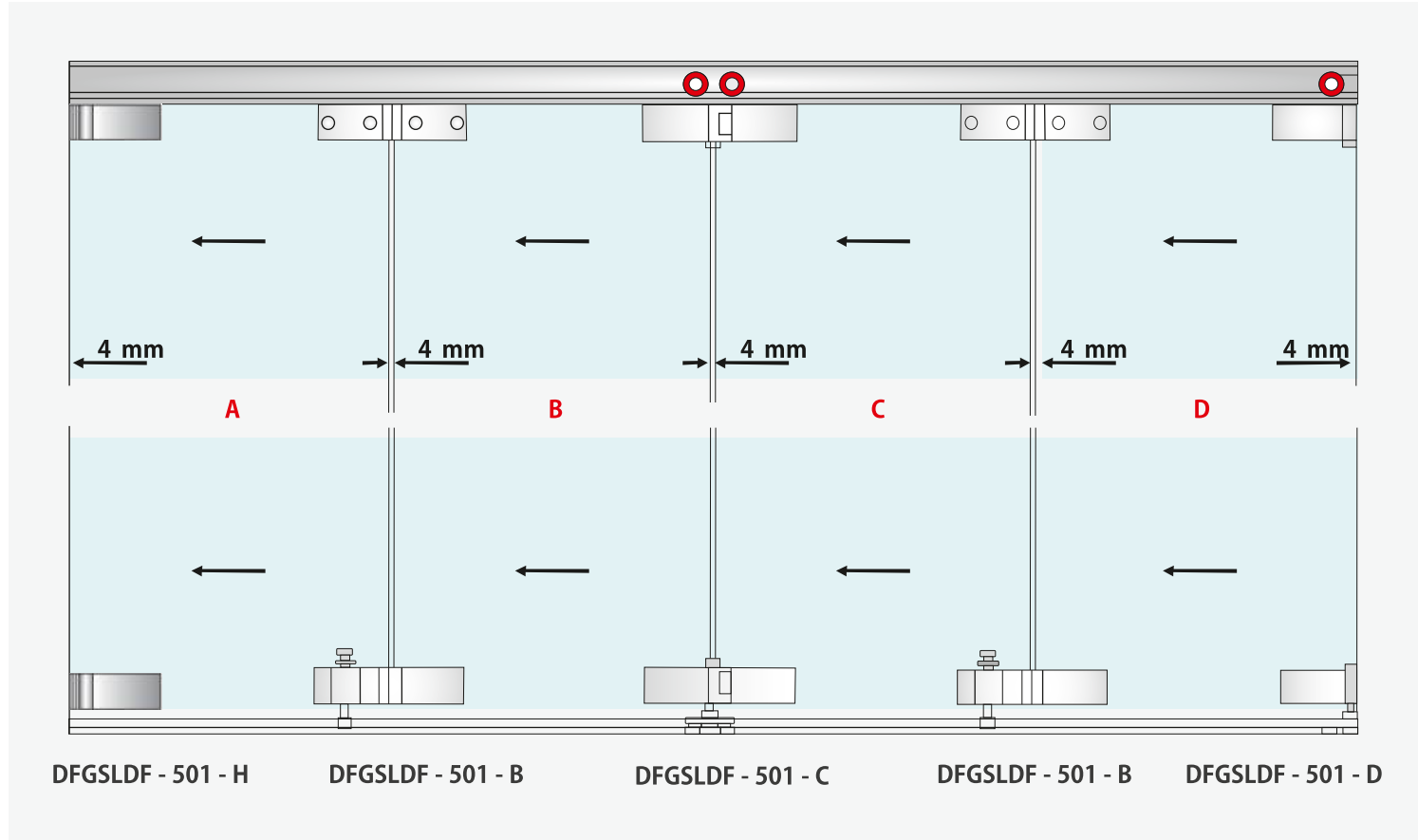

DFGSLDF-501-H
(SSS/PSS)

DFGSLDF-501-B
(SSS/PSS)

DFGSLDF-501-C
(SSS/PSS)

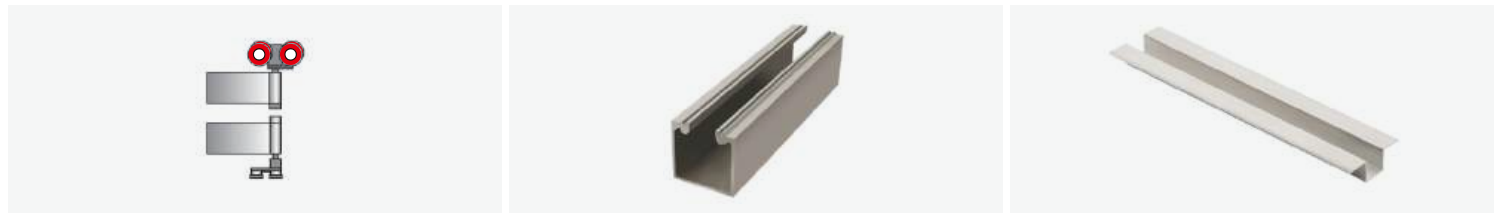

DFGSLDF-501-D
(SSS/PSS)

DF-WSGF-011
(Alu.)

DF-SC-043
(Alu.)

PRODUCT	DFGSLDF - 501 H	DFGSLDF - 501 B	DFGSLDF - 501 C	DFGSLDF - 501 D	DFGSLDF-501-S
For 2 Glass Panel	01 Set.	01 Set.	--	01 Set.	As Per Optional
For 3 Glass Panel	01 Set.	01 Set.	01 Set.	--	As Per Optional
For 4 Glass Panel	01 Set.	02 Set.	01 Set.	01 Set.	As Per Optional
For 5 Glass Panel	01 Set.	02 Set.	02 Set.	--	As Per Optional
For 6 Glass Panel	01 Set.	03 Set.	02 Set.	01 Set.	As Per Optional

● Glass Sliding & Folding System - 511 H / S.S. 304

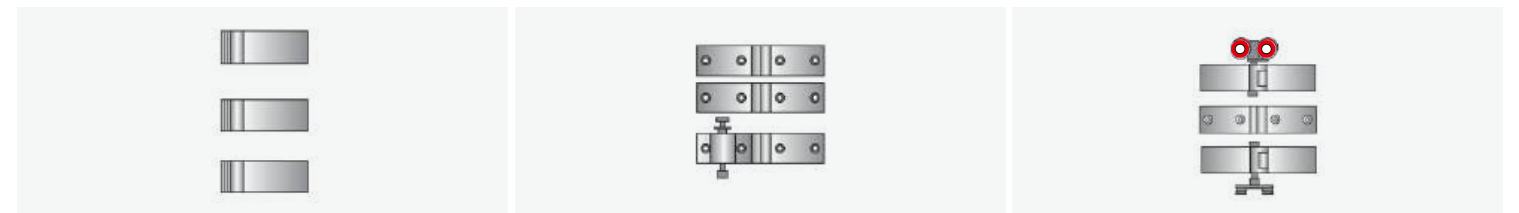
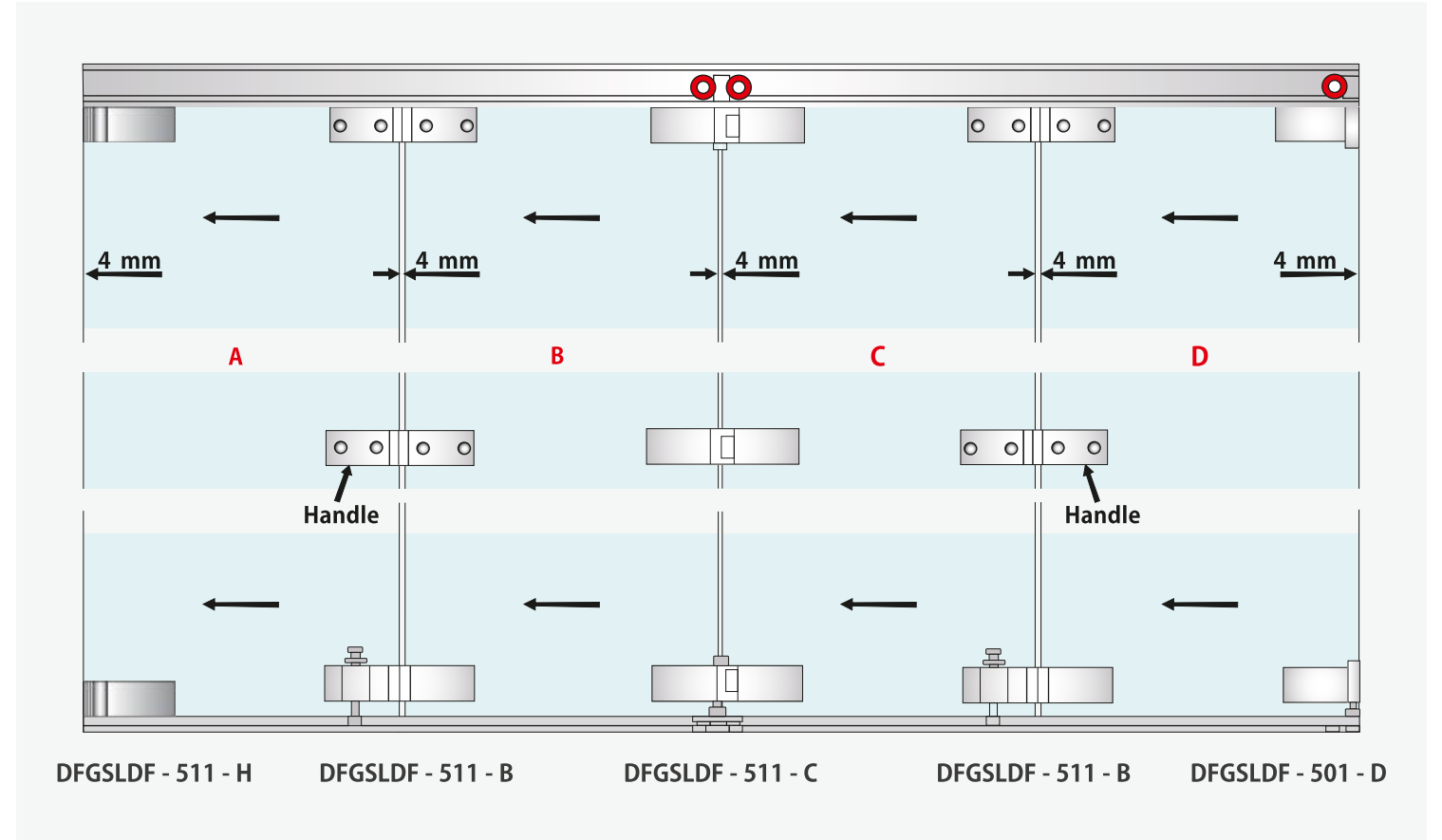

DFGSLDF-511-H
(SSS/PSS)

DFGSLDF-511-B
(SSS/PSS)

DFGSLDF-511-C
(SSS/PSS)

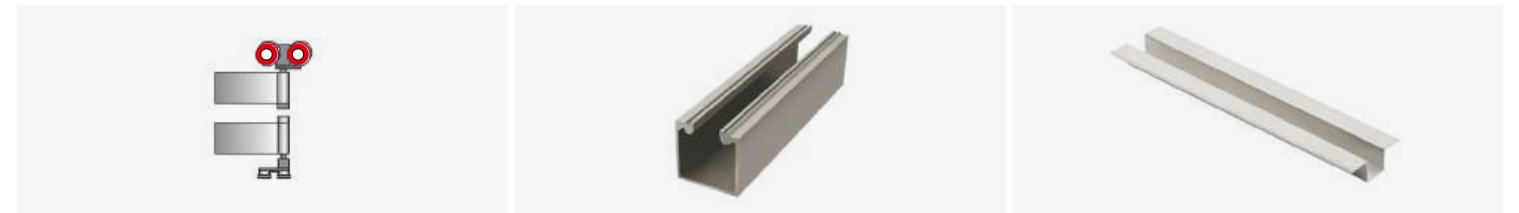

DFGSLDF-501-D
(SSS/PSS)

DF-WSGF-011
(Alu.)

DF-SC-043
(Alu.)

PRODUCT	DFGSLDF-511-H	DFGSLDF-511-B	DFGSLDF-511-C	DFGSLDF-501-D	DFGSLDF-501-S
For 2 Glass Panel	01 Set.	01 Set.	--	01 Set.	As Per Optional
For 3 Glass Panel	01 Set.	01 Set.	01 Set.	--	As Per Optional
For 4 Glass Panel	01 Set.	02 Set.	01 Set.	01 Set.	As Per Optional
For 5 Glass Panel	01 Set.	02 Set.	02 Set.	--	As Per Optional
For 6 Glass Panel	01 Set.	03 Set.	02 Set.	01 Set.	As Per Optional

● Glass Center Sliding & Folding System - 901 P / S.S. 304

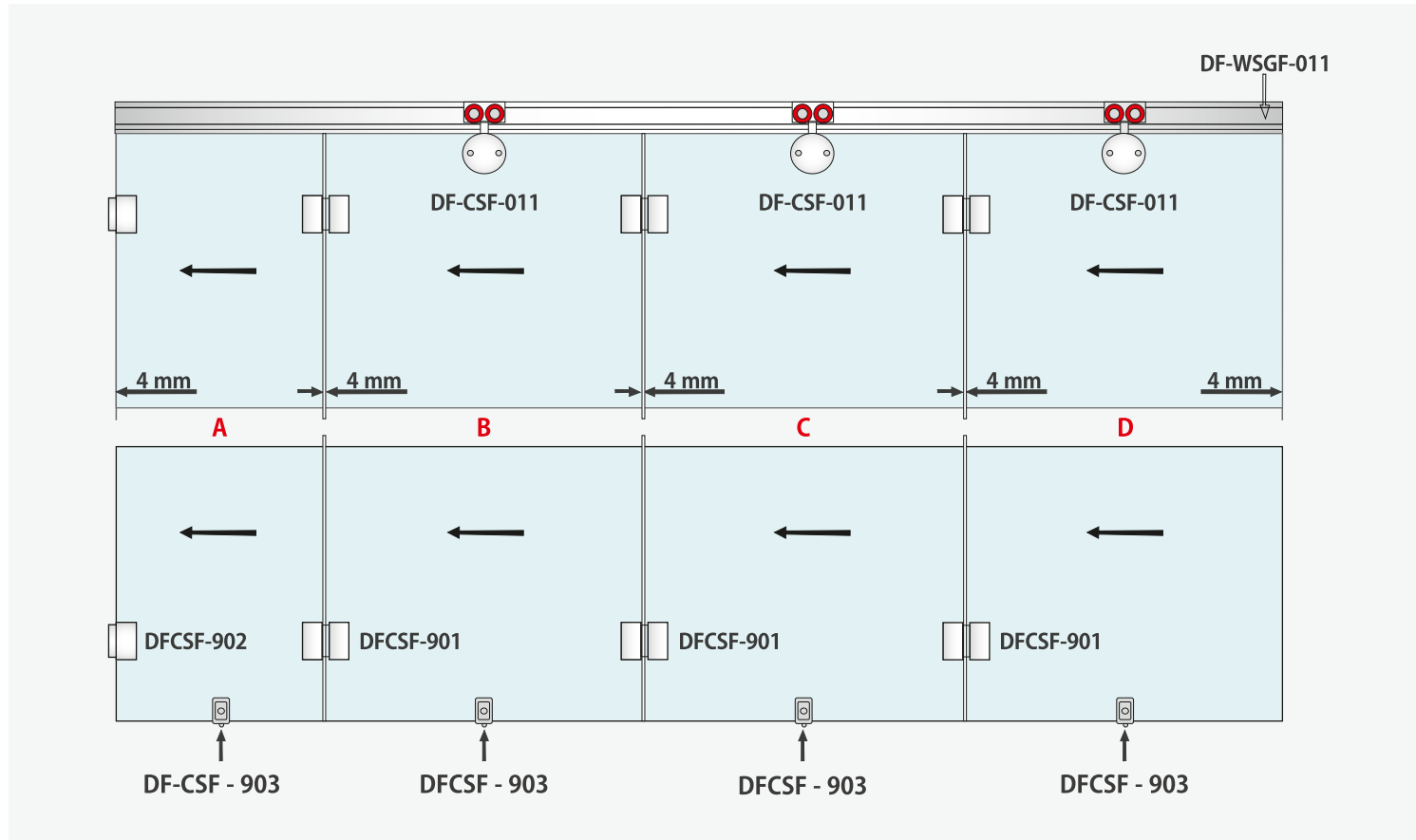

DF-CSF-011 (SSS/PSS) DF-CSF-011SQ (SSS/PSS) DF-CSF-901 (SSS/PSS) DF-CSF-902 (SSS/PSS)

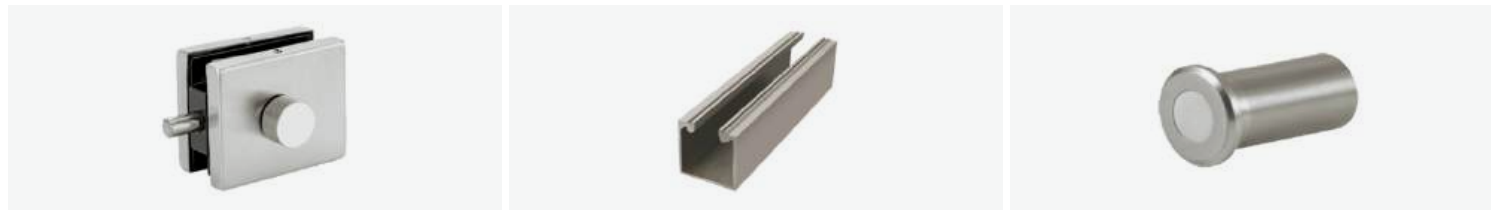

DF-CSF-903 (SSS/PSS) DF-WSGF-011 (Alu.) DF-CSF-904 (SSS/PSS)



PRODUCT	DF-CSF-011	DF-CSF-901	DF-CSF-902	DF-CSF-903	DF-CSF-904
For 2 Glass Panel	01 Pcs.	02 Pcs.	02 Pcs.	As Per Required	As Per Required
For 3 Glass Panel	02 Pcs.	04 Pcs.	02 Pcs.	As Per Required	As Per Required
For 4 Glass Panel	03 Pcs.	06 Pcs.	02 Pcs.	As Per Required	As Per Required
For 5 Glass Panel	04 Pcs.	08 Pcs.	02 Pcs.	As Per Required	As Per Required
For 6 Glass Panel	05 Pcs.	10 Pcs.	02 Pcs.	As Per Required	As Per Required

● Wooden Sliding and Folding System- 601

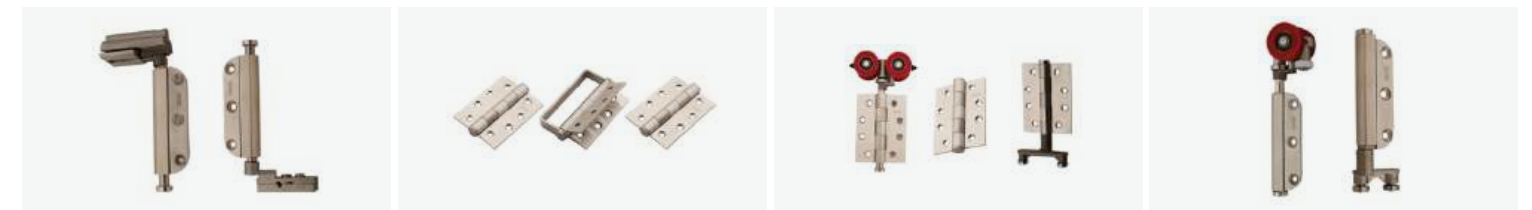
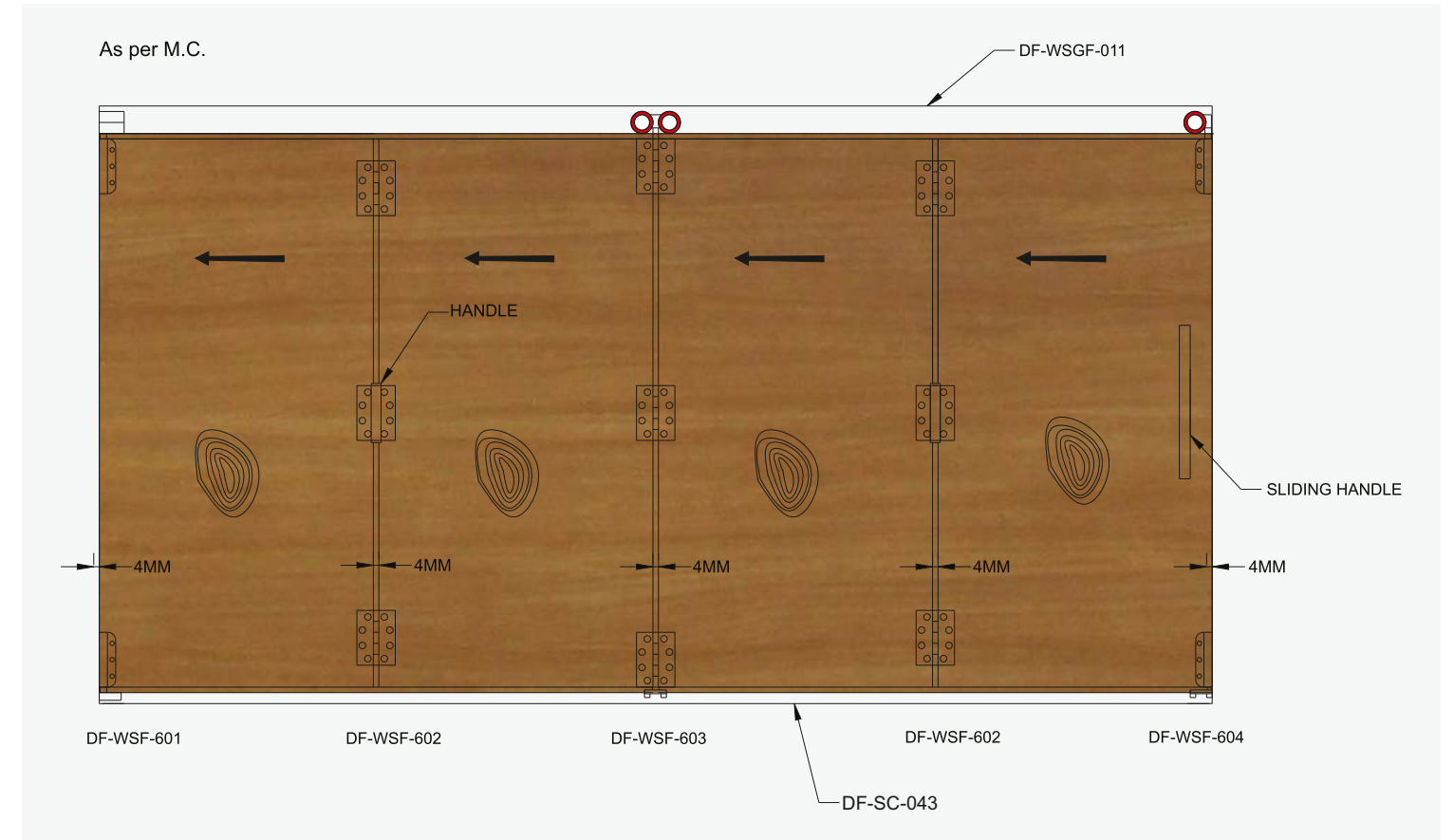

DF-WSF-601 (SSS/PSS) DF-WSF-602 (SSS/PSS) DF-WSF-603 (SSS/PSS) DF-WSF-604 (SSS/PSS)



DF-WSF-605 (SSS/PSS) DF-WSGF-011 (Alu.) DF-SC-043 (Alu.)



PRODUCT	DF-WSF-601	DF-WSF-602	DF-WSF-603	DF-WSF-604
For 2 Glass Panel	01 Set.	01 Set.	--	01 Set.
For 3 Glass Panel	01 Set.	01 Set.	01 Set.	--
For 4 Glass Panel	01 Set.	02 Set.	01 Set.	01 Set.
For 5 Glass Panel	01 Set.	02 Set.	02 Set.	--
For 6 Glass Panel	01 Set.	03 Set.	02 Set.	01 Set.

● Glass Sliding Solution / S.S. 304



DF-SGSF-051Set (SSS/PSS) DF-SGSF-051 (SSS/PSS) DF-SGSF-05 (SSS/PSS) DF-SGSF-053 (SSS/PSS)

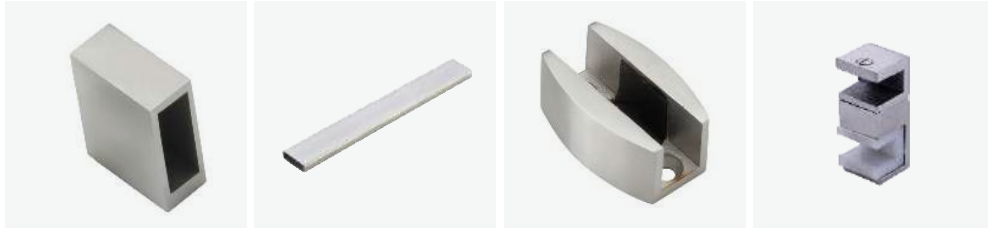

DF-SGSF-054 (SSS/PSS) DF-SGSF-055 (SSS/PSS) DF-SL-11 (SSS/PSS) DF-SL-12 (SSS/PSS)

● Glass Sliding Solution / S.S. 304



DF-SGSF-085 Set (SSS/PSS) DF-SGSF-085 (SSS/PSS) DF-SGSF-086 (SSS/PSS) DF-SGSF-087 (SSS/PSS)



DF-SGSF-055 (SSS/PSS) DF-SL-11 (SSS/PSS) DF-SGH-03 (SSS/PSS)

● Glass Sliding Solution / S.S. 304



DF-SGF-022 (SSS/PSS) DF-SGF-023 (SSS/PSS) DF-SGF-024 (SSS/PSS) DF-SGF-025 (SSS/PSS)

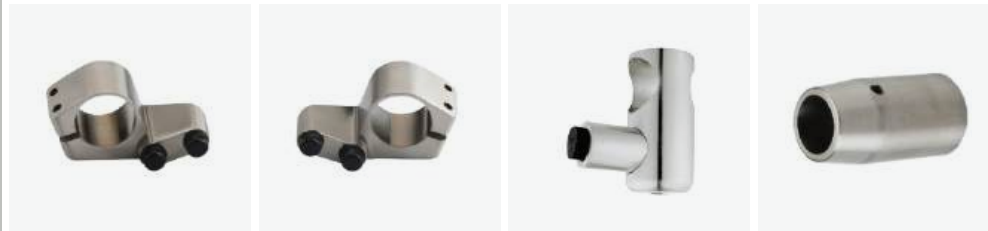

DF-SGF-026 R (SSS/PSS) DF-SGF-026 L (SSS/PSS) DF-SGF-027 (SSS/PSS) DF-SGF-028 (SSS/PSS)



DF-SGF-029 (SSS/PSS) DF-SGF-030 (SSS/PSS) DF-HL-11 (SSS/PSS) DF-SGSF-054 A (SSS/PSS) DF-SGSF-054 G (SSS/PSS) DF-SGSF-054 T (SSS/PSS)

● Glass Sliding Solution / S.S. 304



DF-GSF-011 (SSS/PSS) DF-GSF-011 A (SSS/PSS) DF-GSF-011 B (SSS/PSS) DF-GSF-011 C (SSS/PSS)



DF-SGF-012 (Alu.) DF-SGF-013 (Alu.) DF-SGF-014 (Alu.) DF-GSF-034 A (SSS/PSS) DF-GSF-034 B (SSS/PSS) DF-GSF-034 C (SSS/PSS)



DF-GSF-034 D (SSS/PSS) DF-SLD-055 (Alu.) DF-SGF-015 (SSS/PSS) DF-SGF-016 (White) DF-SGF-017 (White) DF-GSF-012 (SSS/PSS)



DF-GSF-012 A (SSS/PSS) DF-SGF-014 A (Alu.) DF-SGSF-095 (SSS/PSS) DF-SGSF-065 (Alu.) DF-SGSF-066 (CP)

● Glass Sliding Door Handles

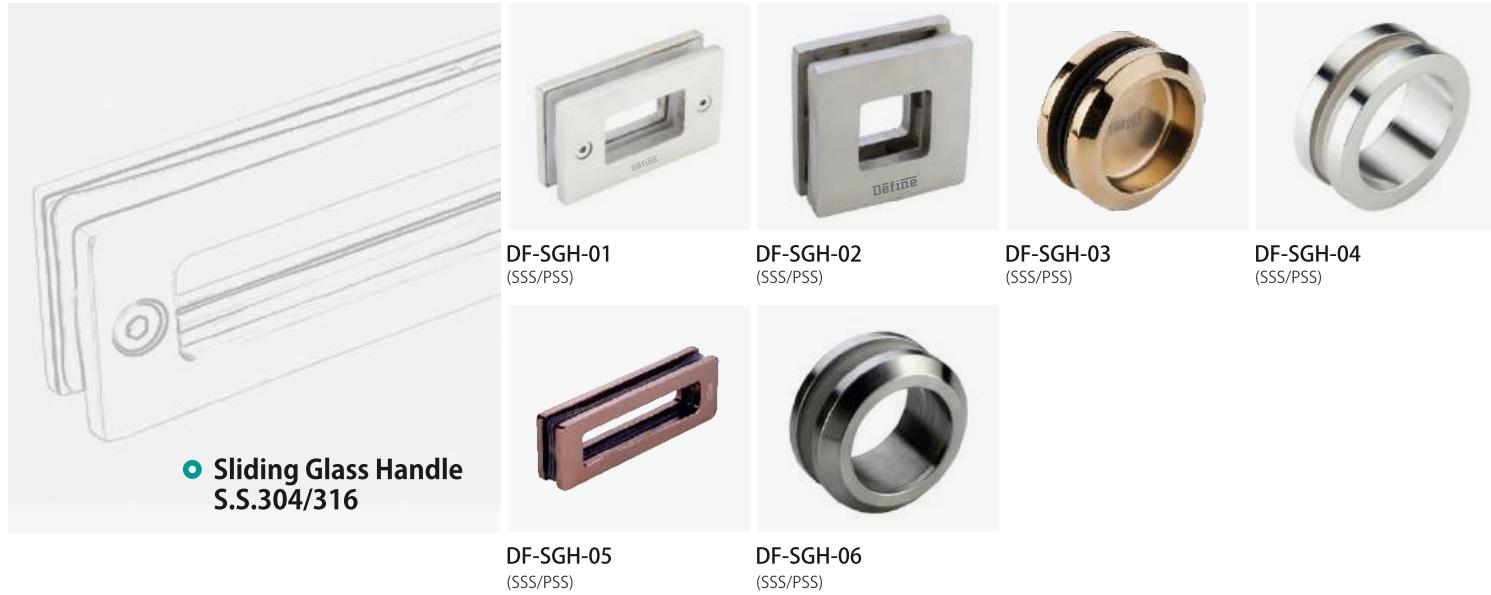

DF-SGH-01
(SSS/PSS)

DF-SGH-02
(SSS/PSS)

DF-SGH-03
(SSS/PSS)

DF-SGH-04
(SSS/PSS)

DF-SGH-05
(SSS/PSS)

DF-SGH-06
(SSS/PSS)

● Sliding Glass Door Locks



DF-SGHL-521
(SSS)

DF-SGHL-522
(SSS)

DF-SGHL-523
(SSS)

DF-SGHL-524
(SSS)

● Sliding Glass Door Locks



DF-SGHL-525
(SSS)

DF-SGHL-525 S
(SSS)

● Glass Door Locks (Without Cutout)

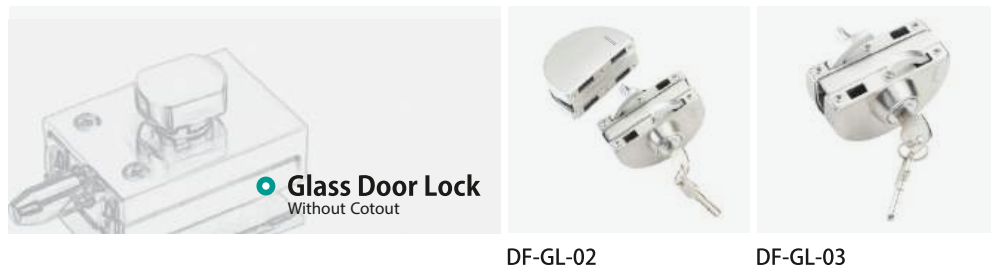

DF-GL-02

DF-GL-03

● Glass Point Fittings



DF-SGSF-074
(SSS/PSS)

DF-SGSF-075
(SSS/PSS)

DF-SGSF-076
(SSS/PSS)

DF-SGSF-077
(SSS/PSS)

DF-SGSF-078
(SSS/PSS)

DF-SGSF-079
(SSS/PSS)

DF-SGSF-080
(SSS/PSS)

● Glass Point Fittings



● Point Fitting System
S.S.304



DF-PF-01
(SSS/PSS)
Size : 60,82,103mm

DF-PF-02
(SSS/PSS)
Size : 60,82,103mm

DF-PF-03
(SSS/PSS)
Size : 75,103mm

DF-PF-04
(SSS/PSS)
Size : 60,82,103mm

DF-PF-05
(SSS/PSS)
Size : 60,82mm

DF-PF-06
(SSS/PSS)
Size : 82mm



DF-PF-07
(SSS/PSS)
Non Registrable

DF-PF-08
(SSS/PSS)
Non Registrable

DF-FMD-33
(SSS/PSS)

DF-FMD-34
(SSS/PSS)

DF-OF-T

Wooden Door Fittings

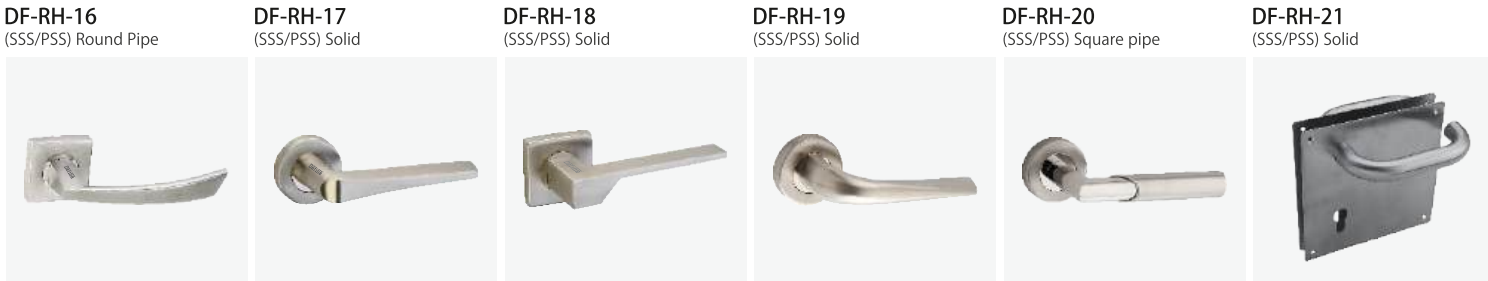
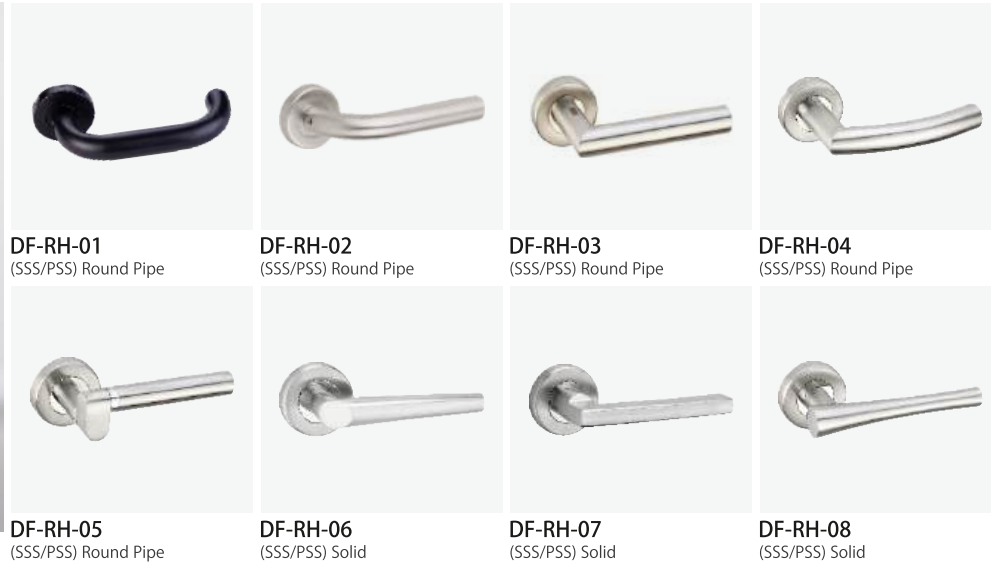
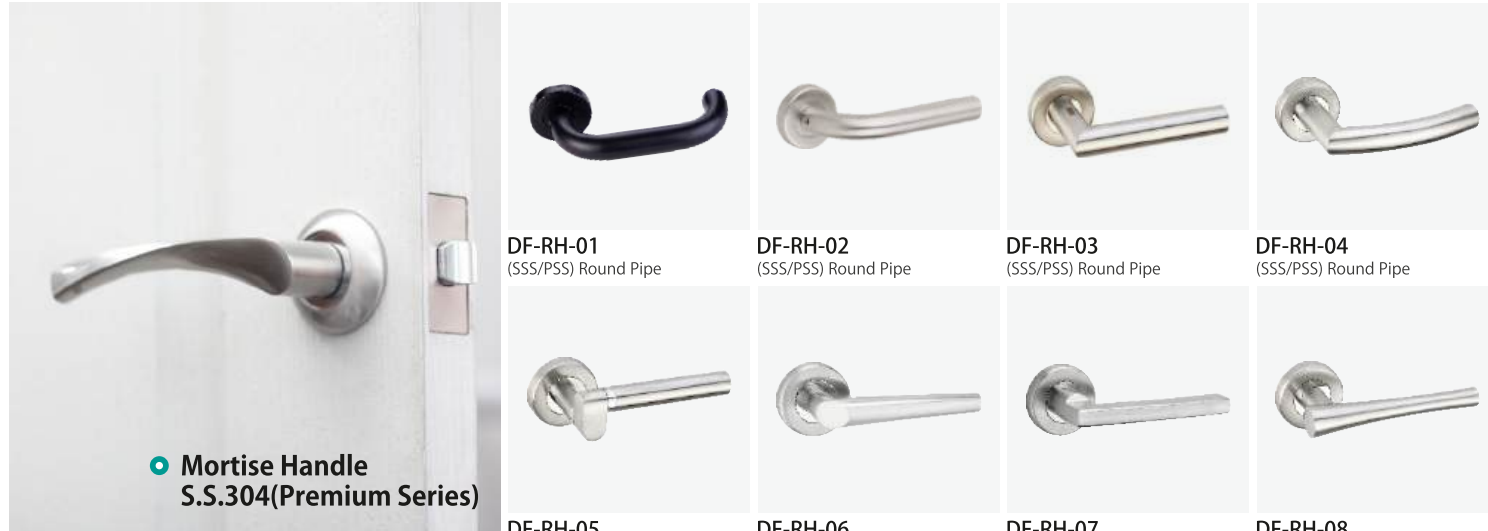

Wooden Door Fittings

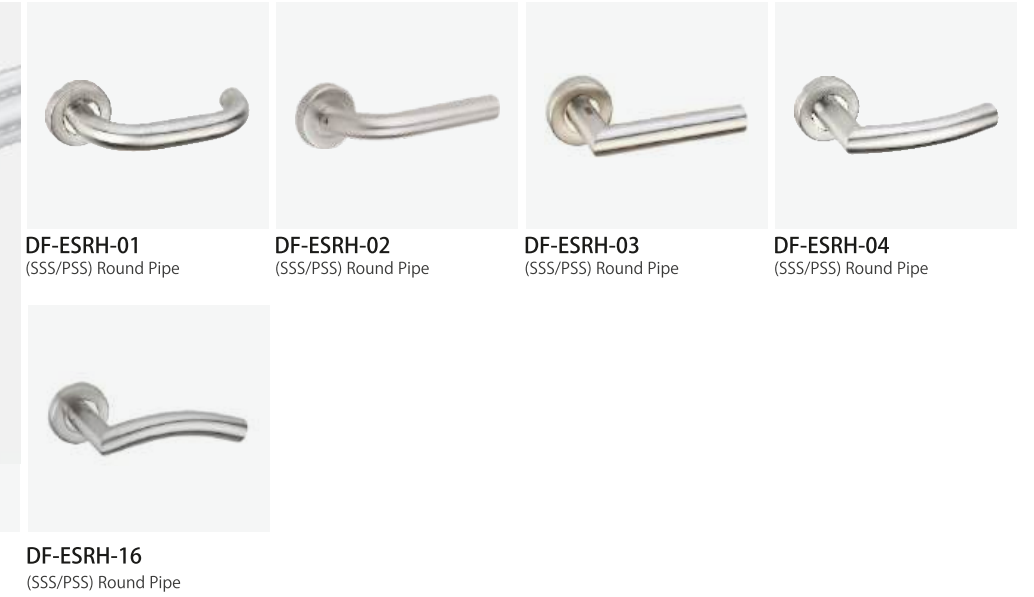
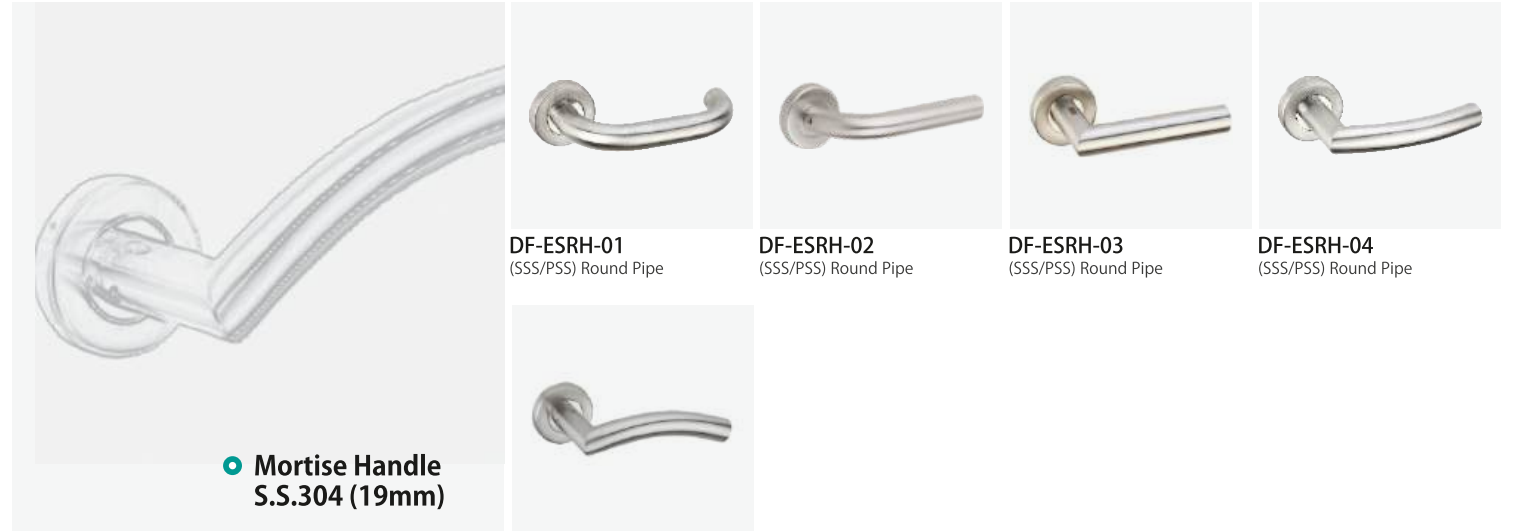

Wooden Door Fittings

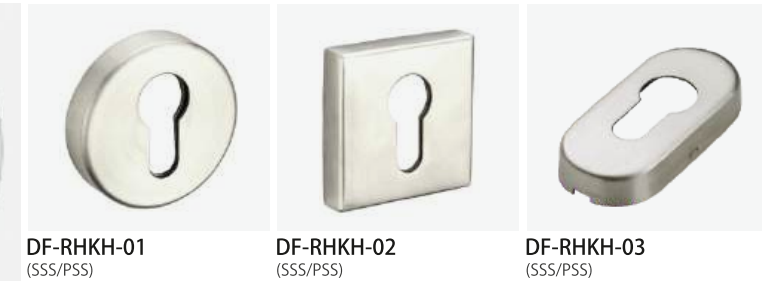
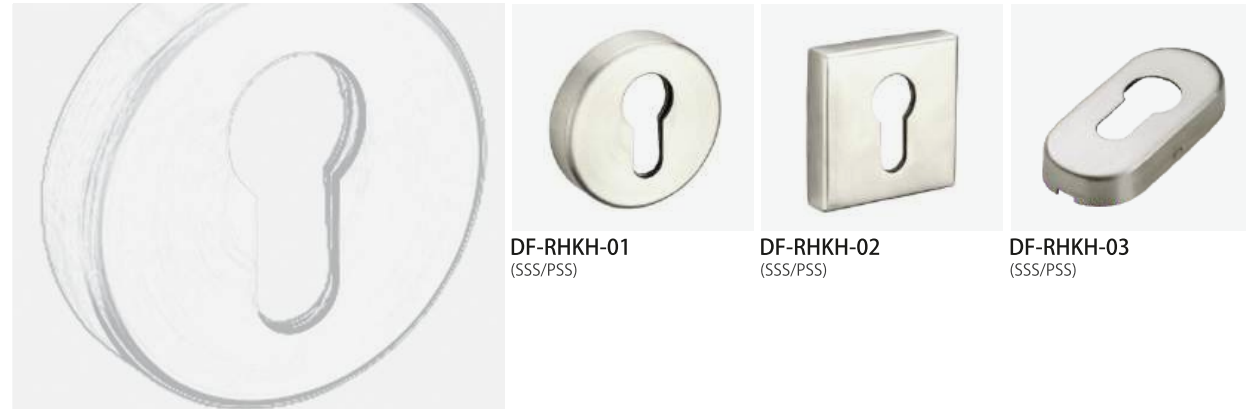

Key Hole S.S.304

Wooden Door Fittings



Wooden Door Fittings



DF-OSK
(BN)
Size : 60/70/80/90/100mm

DF-BSK
(BN)
Size : 60/70/80/90/100mm

DF-CS
(BN)
Size : 60/70/80mm

DF-HCY-KNOB
(BN)
Size : 40mm



DF-HCY-KEY
(BN)
Size : 40mm

Wooden Door Fittings

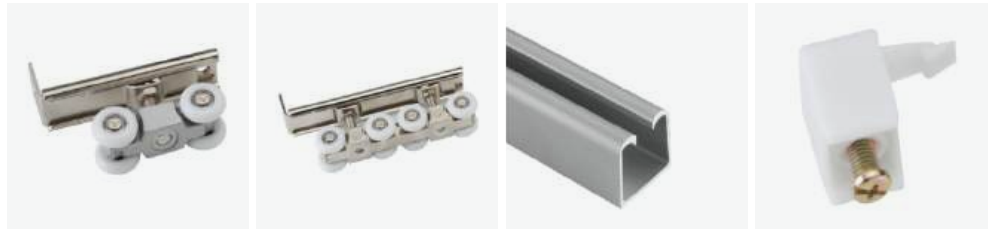

DF-SLD-053
(SSS)

DF-SLD-054
(SSS)

DF-SLD-055
(Alu.)

DF-SLD-057
(White)

Wooden Door Accessories

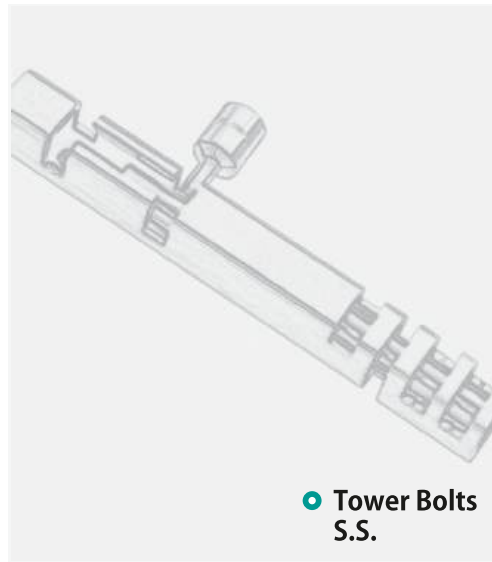

CODE	FINISH	SIZE	CODE	FINISH	SIZE
DF-TBE-04	SSS	4"	DF-TBSQ-04	SSS	4"
DF-TBE-06	SSS	6"	DF-TBSQ-06	SSS	6"
DF-TBE-08	SSS	8"	DF-TBSQ-08	SSS	8"
DF-TBE-10	SSS	10"	DF-TBSQ-10	SSS	10"
DF-TBE-12	SSS	12"	DF-TBSQ-12	SSS	12"
DF-TBE-18	SSS	18"			

Wooden Door Accessories

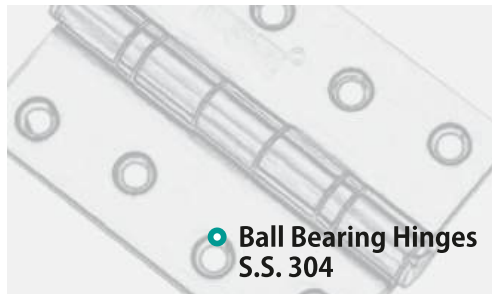

CODE	FINISH	SIZE
DF-BBH-04	SSS	4"
DF-BBH-05	SSS	5"

Wooden Door Accessories

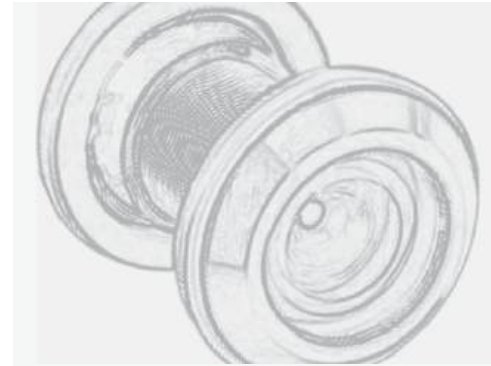

DF-DE-01
(SSS/PSS)

DF-DS-01
(SSS/PSS)

DF-DS-02
(SSS/PSS)

DF-DS-03
(SSS/PSS)

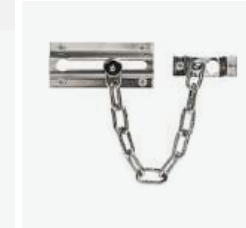

DF-DC-01
(SSS/PSS)

Signage Plate

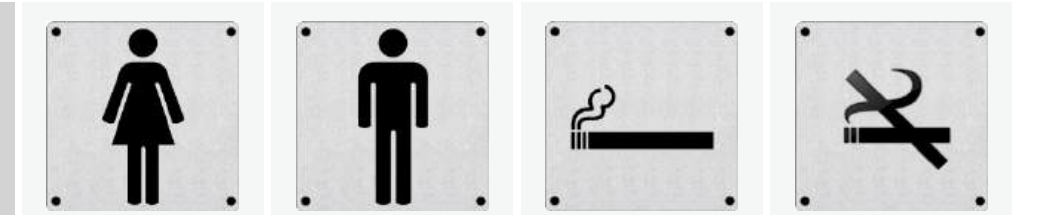

DF-SNP-01
(SSS)

DF-SNP-02
(SSS)

DF-SNP-03
(SSS)

DF-SNP-04
(SSS)

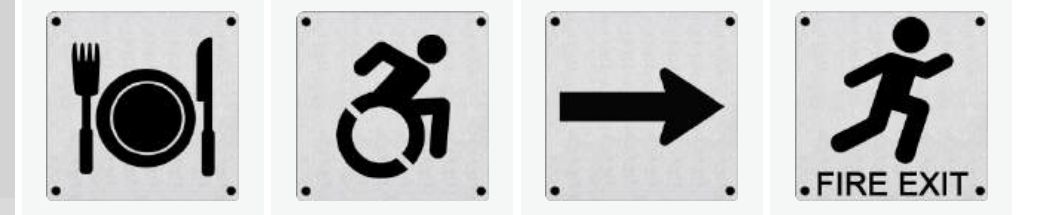

DF-SNP-05
(SSS)

DF-SNP-06
(SSS)

DF-SNP-07
(SSS)

DF-SNP-08
(SSS)



DF-SNP-09
(SSS)

DF-SNP-10
(SSS)

DF-SNP-11
(SSS)

DF-SNP-12
(SSS)

DF-SNP-13
(SSS)

DF-SNP-14
(SSS)

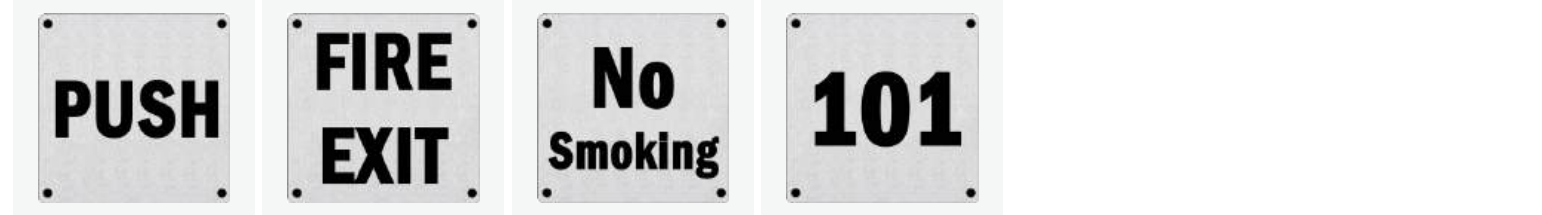

DF-SNP-15
(SSS)

DF-SNP-16
(SSS)

DF-SNP-17
(SSS)

DF-SNP-18
(SSS)

Wooden Door Fittings

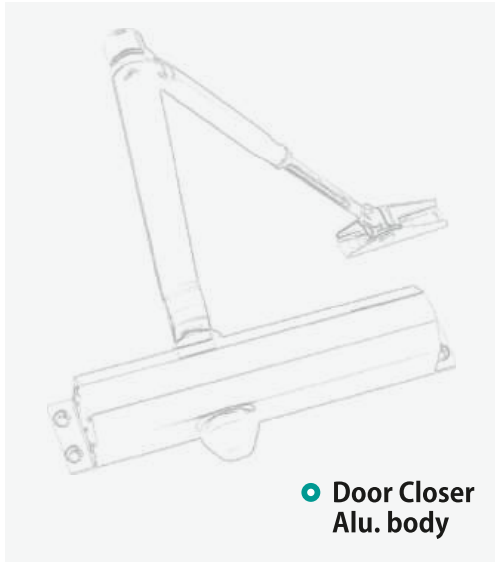

DF-DC-100 (Silver) Weight Capacity : 45 to 60 kg



DF-DC-200 (Silver) Weight Capacity : 60 to 80 kg



DF-DC-OHPA (Silver)

Wooden Door Fittings

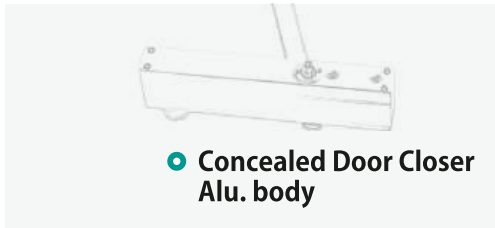

DF-DC-500 (Silver)



DF-DC-700 (Silver)

Glass Glazing Profile S.S.



DF-LGP-092 (Alu.)

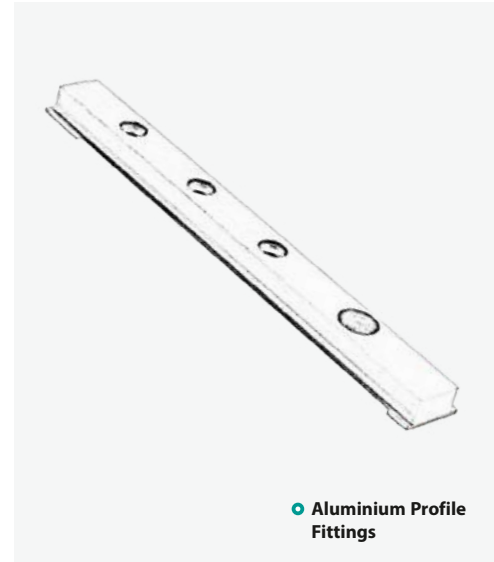

DF-AHS-01 (SSS/PSS)



DF-APB-01 (Mill)



DF-APB-02 (Mill)



DF-APB-03 (SSS)

INFORMATION

- The Technical Presentation and Dimension in Illustration and Drawing are non Binding.
We Reserve the Right to Make any Changes to Specification at any Time.
We Do Not Accept any Responsibility for any Errors Which May Occurs in the Production of this Catalogue or Price List.
The Products in This List are the Ones that are Currently in the DEFINE Product Range, Since Our Product Range Changes at any Time, Please Contact Us if You Cannot Find any Particular Information.
The Printed Color Indicating the Surface Finishes are not 100% True, But Do Provide A Useful Guide.
Picture May Show Designs Which Are Different to the Scope of Actual Product.
Dimension and Rate are Subject to Change Without any Prior Notice.

Note :

Lined area for notes with horizontal dashed lines.

Note :

Dotted lines for note-taking.



Precision Engineering & Durability



Innovative Designs



Sustainability



Custom Solutions



Comprehensive Product Range



INFORMATION

- The Technical Presentation and Dimension in Illustration and Drawing are non Binding.
- We Reserve the Right to Make any Changes to Specification at any Time.
- We Do Not Accept any Responsibility for any Errors Which May Occurs in the Production of this Catalogue or Price List.
- The Products in This List are the Ones that are Currently in the DEFINE Product Range, Since Our Product Range Changes at any Time, Please Contact Us if You Cannot Find any Particular Information.
- The Printed Color Indicating the Surface Finishes are not 100% True, But Do Provide A Useful Guide.
- Picture May Show Designs Which Are Different to the Scope of Actual Product.
- Dimension and Rate are Subject to Change Without any Prior Notice.